



# CORDLESS SPIN POWER SCRUBBER – CORE TOOL

24-VOLT MAX\* | POLE + HANDHELD

**OPERATOR'S MANUAL**

A Division of Snow Joe®, LLC

**Model 24V-PWSCRB-CT-RM**

Form No. SJ-24V-PWSCRB-CT-RM-880E-M-V1

## THANKS FOR YOUR PURCHASE OF A REMANUFACTURED PRODUCT.

To make sure you get the most out of your product, be sure to register online at

**sunjoe.com**

to enjoy full product support.

PASTE UPC LABEL HERE



# CORDLESS SPIN POWER SCRUBBER – CORE TOOL

24-VOLT MAX\* | POLE + HANDHELD

## OPERATOR'S MANUAL

A Division of Snow Joe®, LLC

Model 24V-PWSCR-B-CT-RM

Form No. SJ-24V-PWSCR-B-CT-RM-880E-M-V1

## IMPORTANT! Safety Instructions

### All Operators Must Read These Instructions Before Use

**⚠️ WARNING!** This indicates a hazardous situation, which, if not avoided, could result in death or serious injury.

**⚠️ CAUTION!** This indicates a hazardous situation, which, if not avoided, could result in minor or moderate injury.

**⚠️ DANGER!** This indicates a hazardous situation, which, if not followed, will result in death or serious injury.

### General Safety

**⚠️ WARNING!** This appliance is not intended for use by children or by unassisted, unsupervised persons whose physical, sensory, or mental capabilities prevent them from using it safely. Children should be supervised to ensure that they do not play with the appliance.

Before starting up your power scrubber, please check it carefully for any defects. If you find any, do not start up your power scrubber. Contact your authorized Snow Joe® + Sun Joe® dealer or call the Snow Joe® + Sun Joe® customer service center at 1-866-SNOWJOE (1-866-766-9563).

**⚠️ WARNING!** When using the power scrubber, basic safety precautions should always be followed to reduce the risk of fire, electric shock, and personal injury. These include:

- **Know your product** – Know how to stop the power scrubber quickly. Thoroughly familiarize yourself with the controls.
- **Keep bystanders away** – All visitors and pets should be kept a safe distance away from the work area.
- **Use the right product** – Do not use this power scrubber for any job except that for which it is intended.
- **Dress properly** – Do not wear loose clothing or jewelry. They can get caught in moving parts. Protective rubber gloves and non-slip footwear are recommended when working outdoors.
- **⚠️ CAUTION!** – Exercise caution to avoid slipping or falling. Wear protective footwear that will protect your feet and improve your footing on slippery surfaces.

- **Stay alert** – Watch what you are doing. Use common sense. Do not operate the power scrubber when you are tired, or under the influence of alcohol or drugs.
- **Do not overreach** – Keep proper footing and balance at all times.
- **Prevent unintentional starting** – Make sure the switch is off before inserting the battery, picking up, or carrying the power scrubber. Do not carry the power scrubber with your finger on the switch.
- **Use safety glasses** – Also use safety footwear, snug-fitting clothing, protective gloves, and hearing and head protection.
- **Store idle tool indoors** – When not in use, power scrubber should be stored indoors in a dry and safe place out of the reach of children. Do not expose to freezing temperatures.

**⚠️ WARNING!** Do not use this appliance without reading this instruction manual.

**⚠️ WARNING!** Do not use the appliance within range of other people unless they are wearing protective clothing.

**⚠️ WARNING!** Do not block any openings. Keep free of lint, hair, dust, and anything that may affect air flow.

- Do not handle the scrubber's plug with wet or damp hands.
- Do not use scrubber on surfaces that could risk releasing hazardous dust or liquids.
- **Risk of explosion** – Do not spray flammable liquids.
- **Remove the battery** – Remove the battery from the compartment before performing any maintenance task.
- **Keep children away** – To reduce the risk of injury, close supervision is necessary when the power scrubber is used near children. This power scrubber must not be used by children or untrained personnel.
- **Use recommended accessories** – Consult the owner's manual for recommended accessories. The use of improper accessories may cause risk of injury.
- Follow the maintenance instructions specified in the manual.

**⚠️ WARNING!** During cleaning, maintenance, or when replacing parts, disconnect the power scrubber from its power source by removing the battery from the compartment.

**⚠️ WARNING!** Do not pressure-wash the power scrubber, which may cause a short circuit, personal injury, or damage to components.

- **Check for damaged parts** – Do not use the appliance if any important parts of the appliance are damaged.

- Do not allow the battery nor motor to come in contact with water.
- In the event of an accident or breakdown, switch off the power scrubber immediately.

## Specific Safety Warnings for Cordless Power Scrubber

- Always use rubber gloves and proper eye wear to avoid contact from splashing, soaps, or detergents on skin and/or eyes while brush head is spinning and when brushes are removed or attached.
- When done using power scrubber, turn the unit off while brush is still in contact with surface to avoid getting splashed.
- Always test on a small, inconspicuous area before using on a larger area. Always follow manufacturer's guidelines for cleaning and maintenance.
- Do not use with abrasive cleaners on any surface.
- Avoid exposing the power scrubber to excessive water. If power scrubber accidentally becomes submerged in water or water gets into battery charging compartment, shake out liquid and allow power scrubber to dry overnight.
- Choose proper brush attachment and attach to power scrubber as directed in assembly instructions.
- Wet the intended area and apply desired cleaning product.
- Place tip of brush on surface to be cleaned.

## Electrical Safety

1. If the battery charger cord is damaged, please call the Snow Joe® + Sun Joe® customer service center at 1-866-SNOWJOE (1-866-766-9563).
2. If charging the power tool in a damp location is unavoidable, use a residual current device (RCD) protected power supply. The using of an RCD reduces the risk of electric shock.
3. **Do not abuse the charging cord.** Never use the cord for carrying, pulling or unplugging the charger. Keep cord away from heat, oil, sharp edges or moving parts. Damaged or entangled cords increase the risk of electric shock.
4. Battery charger is for indoor use only. Do not charge the power scrubber in rain, or in wet locations.

## Battery & Charger Safety Instructions

**NOTE:** This unit is a core tool. The battery and the charger are not included. They must be purchased separately.

Model 24V-PWSCRB-CT-RM is compatible with the iON+ 24V System batteries and chargers. See page 13 for more information.

We pay a great deal of attention to the design of every battery pack to ensure that we supply you with batteries that are safe, durable and have a high energy density. The battery cells have a wide range of safety devices. Each individual cell is initially formatted and its electrical characteristic curves are recorded. This data is then used exclusively to be able to assemble the best possible battery packs.

Despite all the safety precautions, caution must always be exercised when handling batteries. The following points must be obeyed at all times to ensure safe use. Safe use can only be guaranteed if undamaged cells are used. Incorrect handling of the battery pack can cause cell damage.

**IMPORTANT!** Analyses confirm that incorrect use and poor care of high-performance batteries are the main factors responsible for personal and/or product damage.

**⚠ WARNING!** Use only approved replacement batteries; other batteries may damage the power tool and cause it to malfunction, which can lead to serious personal injury.

**⚠ WARNING!** Do not use a battery pack or appliance that is damaged or modified. Damaged or modified batteries may exhibit unpredictable behavior resulting in fire, explosion or risk of injury.

Do not modify or attempt to repair the appliance or the battery pack except as indicated in the instructions for use and care.

Have your battery pack serviced by a qualified repair person using only identical replacement parts. This will ensure that the safety of the battery pack is maintained.

**⚠ CAUTION!** To reduce the risk of injury, charge the 24V iON+ lithium-ion battery pack only in its designated 24V iON+ lithium-ion charger. Other types of chargers present risk of fire, personal injury and damage. Do not wire a battery pack to a power supply plug or car cigarette lighter. Such misuse will permanently disable or damage the battery pack.

- **Avoid dangerous environments** – Do not charge the battery pack in rain, snow or in damp or wet locations. Do not use the battery pack or charger in the presence of explosive atmospheres (gaseous fumes, dust or flammable materials) because sparks may be generated when inserting or removing the battery pack, which could lead to a fire.
- **Charge in a well-ventilated area** – Do not block the charger vents. Keep them clear to allow for proper ventilation. Do not allow smoking or open flames near a charging battery pack. Vented gases may explode.

**NOTE:** The safe temperature range for the battery is 41°F (5°C) to 105°F (40.5°C). Do not charge the battery outside in freezing weather; charge it at room temperature 59°F - 77°F (15°C - 25°C).

- **Maintain charger cord** – When unplugging the charger, pull the plug, not the cord, from the receptacle to reduce the risk of damage to the electrical plug and cord. Never carry the charger by its cord or yank it by the cord to disconnect it from the receptacle. Keep the cord away from heat, oil and sharp edges. Make sure the cord will not be stepped on, tripped over or subjected to damage or stress when the charger is in use. Do not use the charger with a damaged cord or plug. Replace a damaged charger immediately.
- **Do not use an extension cord unless it is absolutely necessary** – Using the wrong, damaged or improperly wired extension cord poses a risk of fire and electric shock. If an extension cord must be used, plug the charger into a properly wired 16 gauge or larger extension cord with the female plug matching the male plug on the charger. Make sure that the extension cord is in good electrical condition.
- **Use only recommended attachments** – Use of an attachment not recommended or sold by the battery charger or battery pack manufacturer may result in risk of fire, electric shock or personal injury.
- **Unplug charger when not in use** – Make sure to remove battery packs from unplugged chargers.

**⚠ WARNING!** To reduce the risk of electric shock, always unplug the charger before performing any cleaning or maintenance. Do not allow water to flow into the charger. Use a Ground Fault Circuit Interrupter (GFCI) to reduce shock hazards.

- **Do not burn or incinerate battery packs** – Battery packs may explode, causing personal injury or damage. Toxic fumes and materials are created when battery packs are burned.
- **Do not crush, drop or damage battery packs** – Do not use the battery pack or charger if they have sustained a sharp blow, been dropped, run over or have been damaged in any way (i.e. pierced with a nail, hit with a hammer, stepped on, etc.).
- **Do not disassemble** – Incorrect reassembly may pose a serious risk of electric shock, fire or exposure to toxic battery chemicals. If the battery or charger are damaged, contact an authorized Snow Joe® + Sun Joe® dealer or call the Snow Joe® + Sun Joe® customer service center at 1-866-SNOWJOE (1-866-766-9563) for assistance.
- **Battery chemicals cause serious burns** – Never let a damaged battery pack contact the skin, eyes or mouth. Under abusive conditions, liquid may be ejected from the battery; avoid contact. Liquid ejected from the battery may cause irritation or burns. If a damaged battery pack leaks battery chemicals, use rubber or neoprene gloves to safely dispose of it. If skin is exposed to battery fluids, wash the affected area with soap and water and rinse with vinegar. If eyes are exposed to battery chemicals, immediately flush with water for 20 minutes and seek medical attention. Remove and dispose of contaminated clothing.

- **Do not short circuit** – A battery pack will short circuit if a metal object makes a connection between the positive and negative contacts on the battery pack. Do not place a battery pack near anything that may cause a short circuit, such as paperclips, coins, keys, screws, nails and other metallic objects. A short-circuited battery pack poses a risk of fire and severe personal injury.
- **Store your battery pack and charger in a cool, dry place** – Do not store the battery pack or charger where temperatures may exceed 105°F (40.5°C), such as in direct sunlight or inside a vehicle or metal building during the summer.

## Information About the Battery

1. The battery pack supplied with your cordless power tool is only partially charged. The battery pack has to be charged completely before you use the tool for the first time.
2. For optimum battery performance, avoid low discharge cycles by charging the battery pack frequently.
3. Store the battery pack in a cool place, ideally at 59°F (15°C) and charged fully.
4. Lithium-ion batteries are subject to a natural aging process. The battery pack must be replaced at the latest when its capacity falls to just 80% of its capacity when new. Weakened cells in an aged battery pack are no longer capable of meeting the high power requirements needed for the proper operation of your cordless power scrubber, and therefore pose a safety risk.
5. Do not throw battery packs into an open fire as this poses a risk of explosion.
6. Do not ignite the battery pack or expose it to fire.
7. Do not exhaustively discharge batteries. Exhaustive discharge will damage the battery cells. The most common cause of exhaustive discharge is lengthy storage or non-use of partially discharged batteries. Stop working as soon as the performance of the battery falls noticeably or the electronic protection system triggers. Place the battery pack in storage only after it has been fully charged.
8. Protect batteries and the tool from overloads. Overloads will quickly result in overheating and cell damage inside the battery housing even if this overheating is not apparent externally.
9. Avoid damage and shocks. Immediately replace batteries that have been dropped from a height of more than 3 feet (1 meter) or those that have been exposed to violent shocks, even if the housing of the battery pack appears to be undamaged. The battery cells inside the battery may have suffered serious damage. In such instances, please read the waste disposal information for proper battery disposal.
10. If the battery pack suffers overloading and overheating, the integrated protective cutoff will switch off the equipment for safety reasons.

**IMPORTANT!** Do not press the ON/OFF switch any more if the protective cut-off has been activated. This may damage the battery pack.

11. Use only original battery packs. The use of other batteries poses a fire risk and may result in injuries or an explosion.
12. Do not expose a battery pack or appliance to fire or excessive temperature. Exposure to fire or temperature above 266°F (130°C) may cause explosion.
13. Follow all charging instructions and do not charge the battery pack or appliance outside of the temperature range specified in the instructions. Charging improperly or at temperatures outside of the specified range may damage the battery and increase the risk of fire.

## Information About the Charger and the Charging Process

1. Please check the data marked on the rating plate of the battery charger. Be sure to connect the battery charger to a power supply with the voltage marked on the rating plate. Never connect it to a different mains voltage.
2. Protect the battery charger and its cord from damage. Keep the charger and its cord away from heat, oil and sharp edges. Have damaged cords repaired without delay by a qualified technician at an authorized Snow Joe® + Sun Joe® dealer or call the Snow Joe® + Sun Joe® customer service center at 1-866-SNOWJOE (1-866-766-9563).
3. Electrical plugs must match the outlet. Never modify the plug in any way. Do not use any adapter plugs with grounded appliances. Unmodified plugs and matching outlets will reduce the risk of electric shock.
4. Keep the battery charger, battery pack(s) and the cordless tool out of the reach of children.
5. Do not use the supplied battery charger to charge other cordless tools.
6. During periods of heavy use, the battery pack will become warm. Allow the battery pack to cool to room temperature before inserting it into the charger to recharge.
7. Do not overcharge batteries. Do not exceed the maximum charging times. These charging times only apply to discharged batteries. Frequent insertion of a charged or partially charged battery pack will result in overcharging and cell damage. Do not leave batteries in the charger for days on end.
8. Never use or charge batteries if you suspect that it has been more than 12 months since the last time they were charged. There is a high probability that the battery pack has already suffered dangerous damage (exhaustive discharge).
9. Charging batteries at a temperature below 41°F (5°C) will cause chemical damage to the cells and may cause a fire.
10. Do not use batteries that have been exposed to heat during the charging process, as the battery cells may have suffered dangerous damage.
11. Do not use batteries that have suffered curvature or deformation during the charging process or those that exhibit other atypical symptoms (gassing, hissing, cracking, etc.).
12. Never fully discharge the battery pack (maximum recommended depth of discharge is 80%). A complete discharge of the battery pack will lead to premature aging of the battery cells.

## Protection From Environmental Influences

1. Wear suitable work clothes. Wear safety goggles.
2. Protect your cordless tool and the battery charger from moisture and rain. Moisture and rain can cause dangerous cell damage.
3. Do not use the cordless tool or the battery charger near vapors and flammable liquids.
4. Use the battery charger and cordless tools only in dry conditions and at an ambient temperature of 50°F – 122°F (10°C – 50°C).
5. Do not keep the battery charger in places where the temperature is liable to reach over 104°F (40°C). In particular, do not leave the battery charger in a car that is parked in the sunshine.
6. Protect batteries from overheating. Overloads, overcharging and exposure to direct sunlight will result in overheating and cell damage. Never charge or work with batteries that have been overheated – replace them immediately, if possible.
7. Store the charger and your cordless tool only in dry locations with an ambient temperature of 40°F - 104°F (4.5°C - 40°C). Store your lithium-ion battery pack in a cool, dry place at a temperature of 50°F - 68°F (10°C - 20°C). Protect the battery pack, charger and cordless tool from humidity and direct sunlight. Only place fully charged batteries in storage.
8. Prevent the lithium-ion battery pack from freezing. Battery packs that were stored below 32°F (0°C) for more than 60 minutes must be discarded.
9. When handling batteries, be wary of electrostatic charge. Electrostatic discharges can damage the electronic protection system and the battery cells. Avoid electrostatic charging and never touch the battery poles.

## Product Description









### Purpose

- This cordless power scrubber is intended for residential use only. The scrubber can be used just with the head and handle as it arrives, or with the provided pole attachment for extra length. The scrubber comes with four different brush attachments designed for heavy to light duty cleaning jobs in areas like bathroom, kitchen, home interior, vehicles, and more. Its adjustable, water-resistant head can tilt up to 45° for easy access to difficult areas.



# Safety Symbols

The following table depicts and describes safety symbols that may appear on this product. Read, understand, and follow all instructions on the power scrubber before attempting to assemble and operate.

Symbols	Descriptions	Symbols	Descriptions
	<b>READ THE OPERATOR'S MANUAL(S)</b> – Read, understand, and follow all instructions in the user manual(s) before attempting to assemble and operate.		<b>SAFETY ALERT</b> – Indicates a precaution, a warning, or a danger.
	<b>WARNING!</b> Do not expose the unit to rain or wet conditions. Keep dry.		<b>WEAR EYE AND HEARING PROTECTION</b> – For protection against injury, wear ear defenders and safety goggles.
	Spinning brush. Keep hands away.		Wear safety gloves during use to protect hands.
	Store indoors. Never store the power scrubber outdoors. If the pump freezes, permanent damage may result.		Wear non-slip footwear that will protect your feet and improve your footing on slippery surfaces.
	Indoor use only. Only use battery charger indoors.		

# Know Your Cordless Power Scrubber

Read the owner's manual and safety rules carefully before operating the power scrubber. Compare the illustration below to the power scrubber in order to familiarize yourself with the location of the various controls and adjustments. Save this manual for future reference.

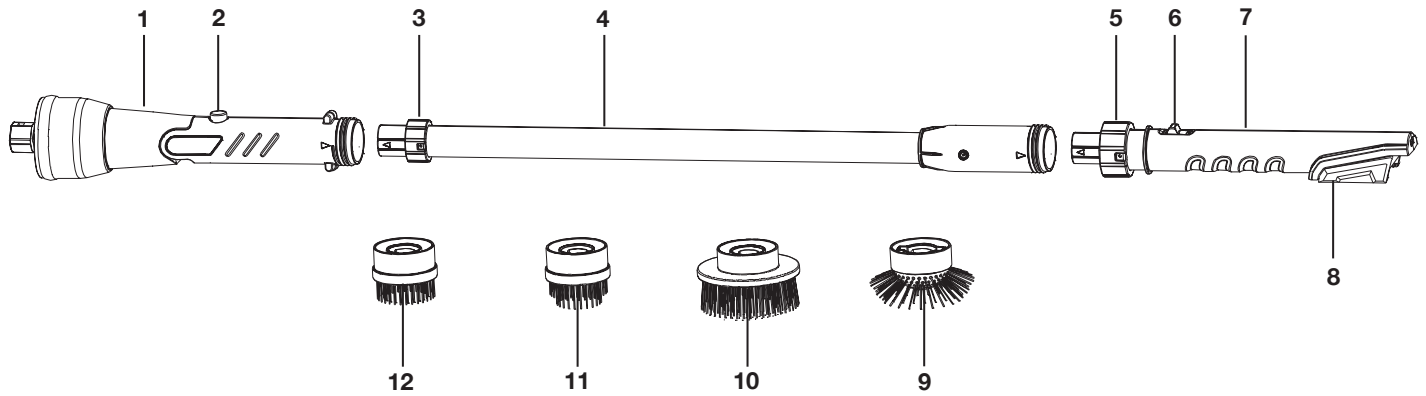

- 1. Scrubber head
- 2. Head adjustment button
- 3. Pole locking collar
- 4. Pole attachment
- 5. Handle locking collar
- 6. On/Off switch (2 speed settings)
- 7. Scrubber handle

- 8. Battery compartment
- 9. Round brush
- 10. Large flat brush
- 11. Cone brush
- 12. Small flat brush

**SOLD SEPARATELY**

Battery + Charger options available at [sunjoe.com](http://sunjoe.com)

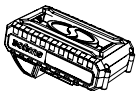

24VBAT-LTW



24VBAT-LTX



24VBAT-LTE

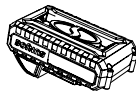

24VBAT-LT



24VBAT



24VBAT-XR



24VCHRG-QC

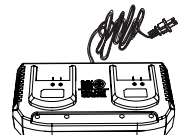

24VCHRG-DPC

## Technical Data

Battery Voltage*	24 V D.C.
Battery Capacity	See page 13 for battery options and specifications
Charging Time Max	See page 13 for battery options and specifications
Battery Run Time Max	See page 13 for battery options and specifications
Max length (head + handle + attachments)	27 in. (69 cm)
Max length (with pole attachment)	50 in. (128 cm)
Variable Speed Settings	2
Brush Speeds	Low 600 rpm High 1000 rpm
Head Tilt Adjustment	45°
Small Flat Brush Diameter	2.4 in. (6 cm)
Cone Brush Diameter	2.4 in. (6 cm)
Large Flat Brush Diameter	3.7 in. (9.5 cm)
Round Brush Diameter	5 in. (12.5 cm)
Weight (without battery)	2.7 lbs (1.2 kg)

\*Initial no-load voltage, when fully charged, peaks at 24 volts; nominal voltage under typical load is 21.6 volts.

## Unpacking

### Carton Contents

- Cordless power scrubber head (pre-assembled)
- Scrubber handle (pre-assembled)
- Pole attachment
- Large flat brush (pre-assembled)
- Small flat brush
- Cone brush
- Round brush
- Manuals with registration card

**NOTE:** In order to operate this cordless power scrubber you will need iON+ 24V System batteries and chargers. See page 13 for battery options and specifications, or visit sunjoe.com.

1. Carefully remove the power scrubber and check to see that all of the above items are supplied.
2. Inspect the product carefully to make sure no breakage or damage occurred during shipping. If you find damaged or missing parts, DO NOT return the unit to the store. Please call the Snow Joe® + Sun Joe® customer service center at 1-866-SNOWJOE (1-866-766-9563).

**NOTE:** Do not discard the shipping carton and packaging material until you are ready to use your new cordless power scrubber. The packaging is made of recyclable materials. Properly dispose of these materials in accordance with local regulations.

**IMPORTANT!** The equipment and packaging material are not toys. Do not let children play with plastic bags, foils, or small parts. These items can be swallowed and pose a suffocation risk!

**⚠️ WARNING!** Do not insert the battery until assembly is complete. Failure to comply could result in accidental starting and possible serious personal injury.

## Battery Pack Operation

The equipment is powered by a lithium-ion battery. The battery pack is completely sealed and maintenance free.

### CORE TOOL





#### BATTERY + CHARGER SOLD SEPARATELY

In order to operate this cordless power scrubber you will need a iON+ 24V System battery and charger. See page 13 for battery and charger options and specifications, or for more information visit sunjoe.com.

### Battery Charge Level Indicator

The battery pack is equipped with a push button for checking the charge level. Simply press the push button to read off the battery charge level from the LEDs of the battery indicator:

- All 3 level monitoring LEDs are lit: Battery charge level is high.
- 2 level monitoring LEDs are lit: Battery charge level is decreasing. Stop work as soon as possible.
- 1 level monitoring LED is lit: Battery is flat. Stop work IMMEDIATELY and charge the battery. Otherwise the battery's service life will be greatly shortened.

Lights	Light Indicators
	Charge level button
	The battery is at 30% capacity and requires charging
	The battery is at 60% capacity and requires charging soon
	The battery is at full capacity



**NOTE:** If the charge level button does not appear to be working, insert the charger and charge as needed.

**NOTE:** Immediately after using the battery pack, the charge level button may display a lower charge than it will if checked a few minutes later. The battery cells “recover” some of their charge after resting.

## Charger Operation

### CORE TOOL

#### BATTERY + CHARGER SOLD SEPARATELY

In order to operate this cordless power scrubber you will need a iON+ 24V System battery and charger. See page 13 for battery and charger options and specifications, or for more information visit [sunjoe.com](http://sunjoe.com).

**⚠ WARNING!** Charge only 24V iON+ lithium-ion battery packs with its compatible 24V iON+ lithium-ion charger. Other types of batteries may cause personal injury and damage. To reduce the risk of electric shock, do not allow water to flow into the charger's AC/DC plug.

### When to Charge the iON+ 24V Lithium-iON Battery

**NOTE:** The iON+ 24V lithium-ion battery packs do not develop a “memory” when charged after only a partial discharge. Therefore, it is not necessary to run down the battery pack before inserting the charger plug.

- Use the battery indicator lights to determine when to charge your iON+ 24V lithium-ion battery pack.
- You can “top-off” your battery pack’s charge before starting a big job or after a long day of use.

### Charging the Battery

1. Push the push lock buttons on the battery to pull the battery out from the battery compartment (Fig. 1).

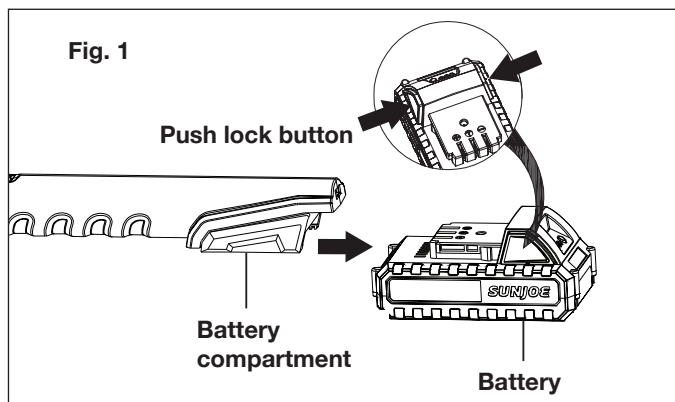

2. Depending on your Snow Joe® + Sun Joe® charger model, how to recharge your lithium-ion battery will vary. You may either insert your 24-volt battery into the 24VCHRG-QC Quick Charger (sold separately) or the 24VCHRG-DPC Dual Port Charger (sold separately) (Figs. 2 – 3).

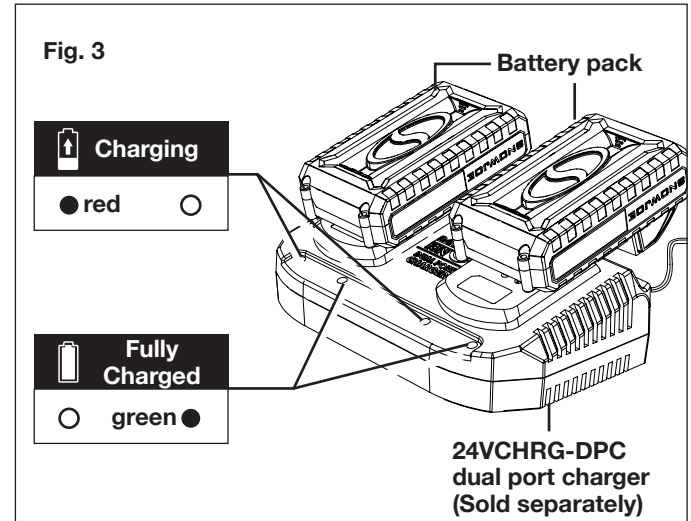
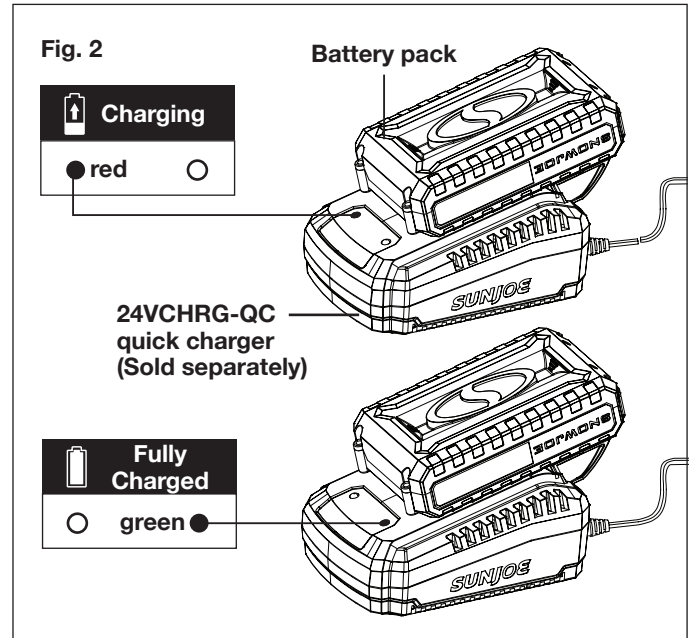

3. The battery indicator LEDs will illuminate one by one during the charging process. Unplug the charger immediately when the 3 LEDs are all illuminated.
4. The 24VCHRG-QC Quick Charger (sold separately) and the 24VCHRG-DPC Dual Port Charger (sold separately) are also equipped with additional charging indicating lights which will indicate the charging status (Figs. 2 – 3).

**⚠ CAUTION!** FIRE HAZARD. When disconnecting the charger from the battery, be sure to unplug the charger from the outlet first, then disconnect the charger from the battery.

**⚠️ WARNING!** The chargers do not automatically turn off when the battery is fully charged. Please take care not to leave the battery plugged into the charger. Switch off or unplug the charger at the mains when charging is complete.

5. Timely recharging of the battery will help prolong the battery's life. You must recharge the battery pack when you notice a drop in the equipment's power.

**IMPORTANT!** Never allow the battery pack to become fully discharged as this will cause irreversible damage to the battery.

6. When charging is complete, remove the battery from the charger by pulling the push lock button and sliding the battery backward to unlock it from the charger.

## Assembly

### Assembling Pole Attachment

1. The power scrubber should arrive pre-assembled with the large flat brush, scrubber head, and handle attached. To add extra length by using the pole attachment, first unscrew the handle locking collar until the handle and head are able to detach (Fig. 4).

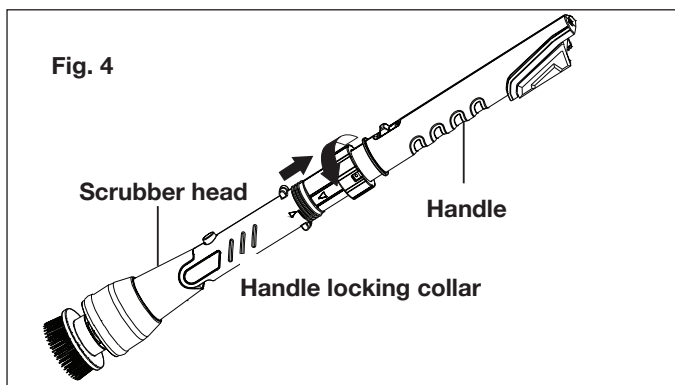

2. Align the arrows on the pole attachment with the arrows on the scrubber head and slide together. Use the pole locking collar to screw in place (Fig. 5).

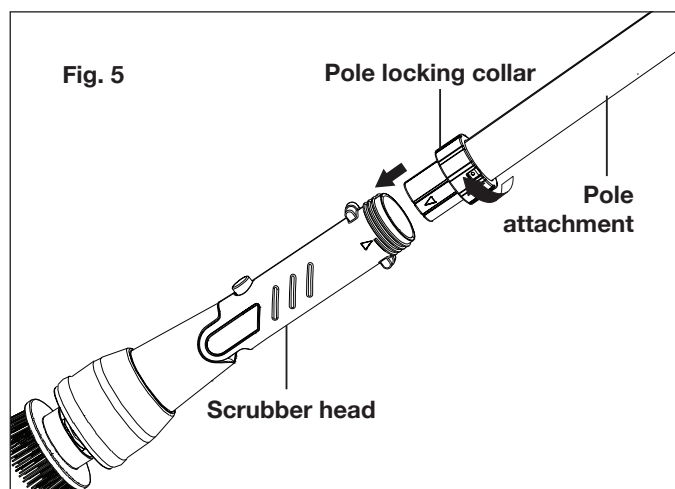

3. Align the arrows on the pole attachment with the arrows on the scrubber handle and slide together. Use the handle locking collar to screw in place (Fig. 6).

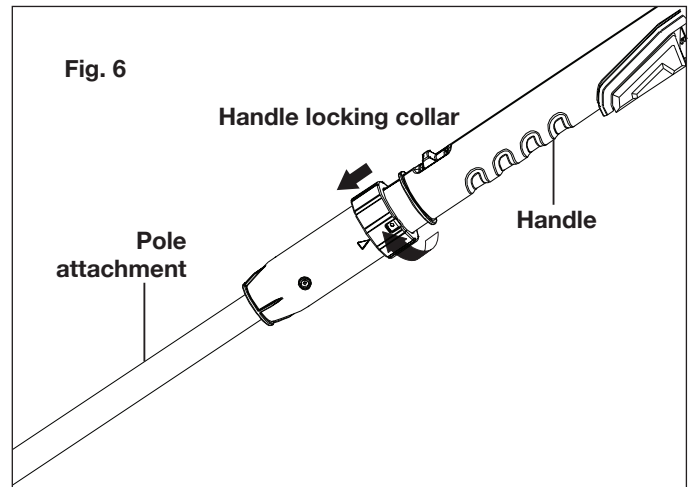

### Changing Brush Attachments

1. To change brush attachments, simply pull the original brush firmly off the head. Then, click the new brush into place (Fig. 7).

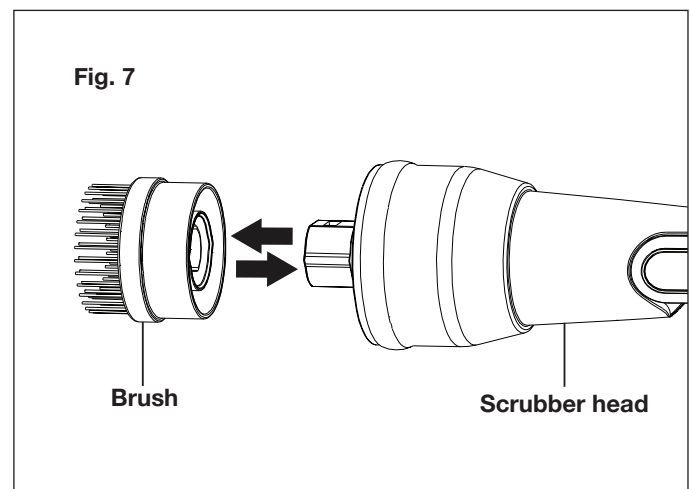

### Using the Brush Attachments

1. The large flat brush is the most firm, suitable for cleaning larger areas of dust, mud, oil stains, and other heavy duty messes (Fig. 8).

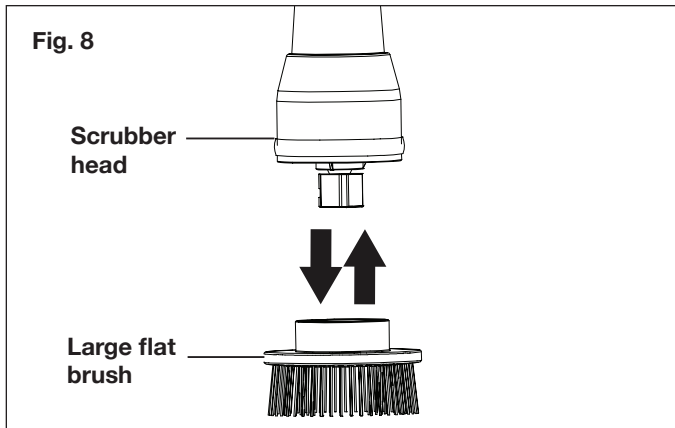

2. The small flat brush has a similar performance to the large flat brush, but is better suited to smaller areas like sink edges (Fig. 9).

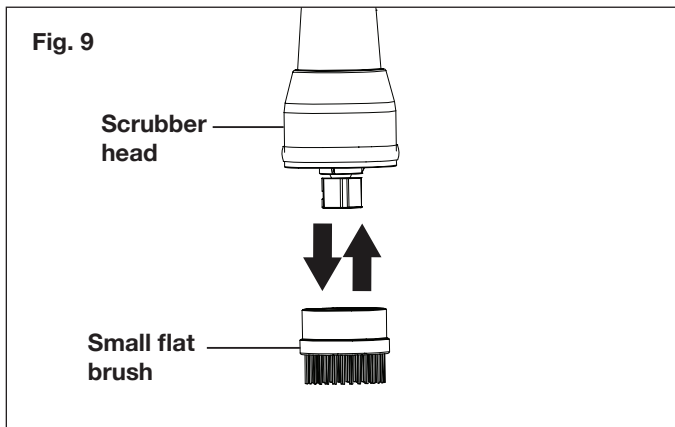

3. The cone brush is moderately firm and ideal for getting into small, hard to reach spaces like grout (Fig. 10).

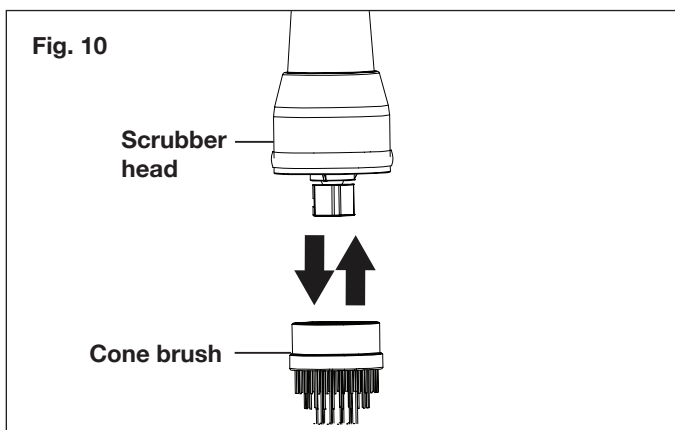

4. The round brush is the least firm and more suitable for curved, irregular surfaces. It is ideal for everyday cleaning, especially on surfaces like tile and porcelain (Fig. 11).

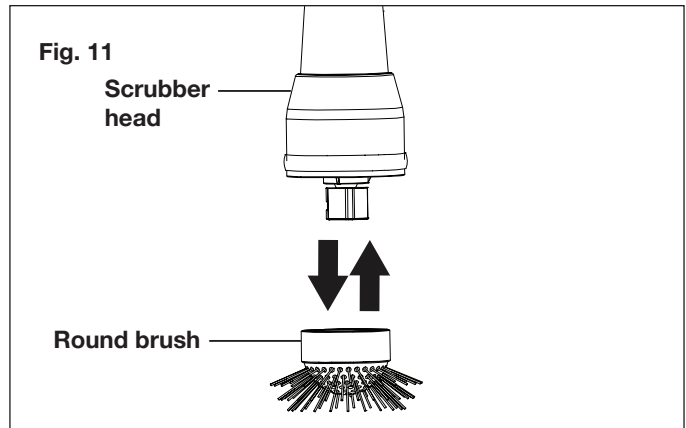

## Operation

To use the power scrubber, be sure to wet the intended area and apply desired cleaning product.

**⚠️ WARNING!** The scrubber head is water-resistant. DO NOT submerge head in water. DO NOT expose handle or battery to water. If the unit accidentally falls into water, shake out loose liquid and allow to dry overnight.

### Adjusting Scrubber Head.

1. Push and hold down the head adjustment button to adjust the angle of the scrubber head if desired. The scrubber head can tilt up to 45° (Fig. 12).

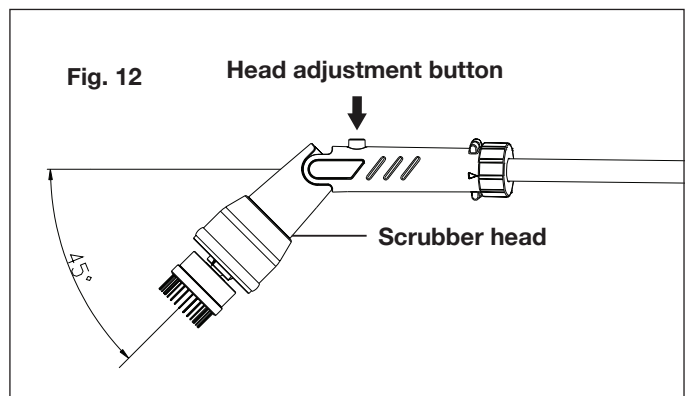

### Starting + Stopping

1. Insert the battery into the battery compartment on the handle (Fig. 13).

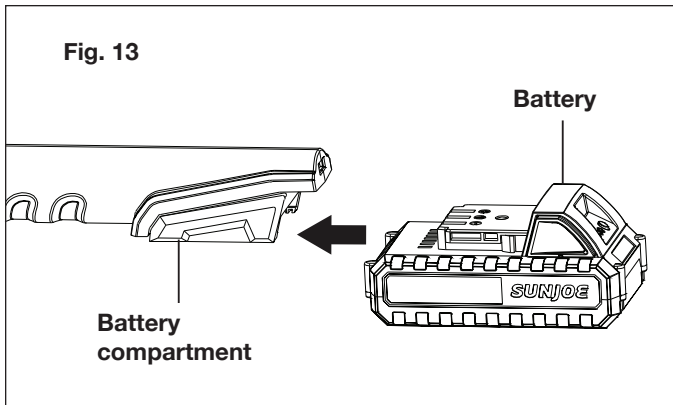

2. Turn the unit on by using one of the brush's two speeds. From the middle OFF setting, slide the switch forward for the slow setting. From the OFF position, slide the switch back for the fast setting (Fig. 14).

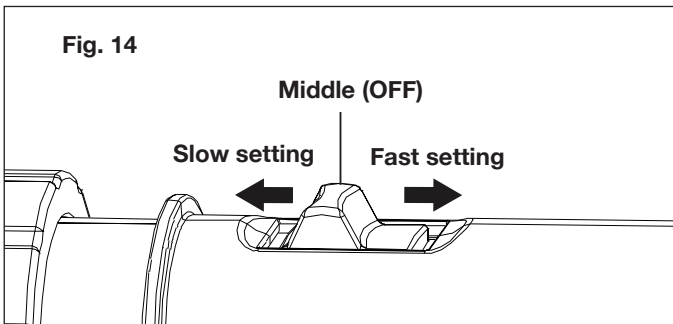

3. When shutting down the unit, keep the brush in contact with the surface to avoid splatter. Slide the switch to the center OFF position (Fig. 14), and remove the battery.

## Maintenance

**CAUTION!** Before working on the cordless power scrubber, switch off the unit and remove the battery from the compartment.

### Cleaning the Scrubber

It is recommended to clean and dry the power scrubber and attachments after each use to maintain optimum functionality for long-term use.

- Clean the scrubber and attachments with a mild detergent and a soft sponge or cloth.
- Make sure the scrubber is completely dry before stored in a safe, dry location. Keep the battery and motor dry at all times.

### Storage

- Store the power scrubber indoors in a safe, dry location.

## Battery Caution + Disposal

Always dispose of your battery pack according to federal, state, and local regulations. Contact a recycling agency in your area for recycling locations.

**CAUTION!** Even discharged battery packs contain some energy. Before disposing, use electrical tape to cover the terminals to prevent the battery pack from shorting, which could cause a fire or explosion.

**WARNING!** To reduce the risk of injury or explosion, never burn or incinerate a battery pack even if it is damaged, dead or completely discharged. When burned, toxic fumes and materials are emitted into the surrounding atmosphere.

1. Batteries vary according to device. Consult your manual for specific information.
2. Install only new batteries of the same type in your product (where applicable).
3. Failure to insert batteries in the correct polarity, as indicated in the battery compartment or manual, may shorten the life of the batteries or cause batteries to leak.
4. Do not mix old and new batteries.
5. Do not mix Alkaline, Standard (Carbon-Zinc) or Rechargeable (Nickel Cadmium, Nickel Metal Hydride, or Lithium-Ion) batteries.
6. Do not dispose of batteries in fire.
7. Batteries should be recycled or disposed of as per state and local guidelines.

## Service + Support

If your Sun Joe® 24V-PWSCR-B-CT-RM cordless power scrubber requires service or maintenance, please call the Snow Joe® + Sun Joe® customer service center at 1-866-SNOWJOE (1-866-766-9563).



## Model + Serial Numbers



When contacting the company, reordering parts, or arranging service from an authorized dealer, you will need to provide the model and serial numbers, which can be found on the decal located on the housing of the unit. Copy these numbers into the space provided below.

Record the following numbers from the housing or handle of your new product:																			
Model #:																			
2	4	V	-	P	W	S	C	R	B	-	C	T	-	R	M				
Serial #:																			

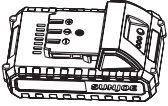
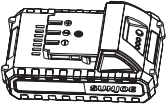
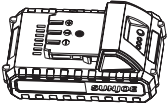
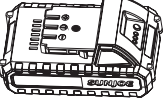
# Optional Accessories

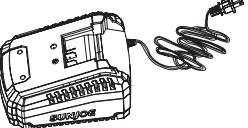
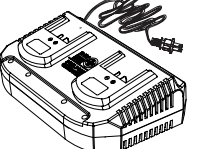
**⚠️ WARNING!** ALWAYS use only authorized Snow Joe® + Sun Joe® replacement parts and accessories. NEVER use replacement parts or accessories that are not intended for use with this cordless power scrubber. Contact Snow Joe® + Sun Joe® if you are unsure whether it is safe to use a particular replacement part or accessory with your power scrubber. The use of any other attachment or accessory can be dangerous and could cause injury or mechanical damage.

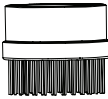
Accessories	Item	Model
<p>1</p> 	<p>24V iON+ 1.3 Ah Lithium-Ion Battery  <i>Battery Charge Time Max:</i>            24VCHRG-AC: 50 min   24VCHRG-QC: 35 min   24VCHRG-DPC: 35 min  <i>Battery Runtime Max: 2 hrs 50 min</i></p>	24VBAT-LTW
<p>2</p> 	<p>24V iON+ 1.5 Ah Lithium-Ion Battery  <i>Battery Charge Time Max:</i>            24VCHRG-AC: 60 min   24VCHRG-QC: 40 min   24VCHRG-DPC: 40 min  <i>Battery Runtime Max: 3 hrs 20 min</i></p>	24VBAT-LTX
<p>3</p> 	<p>24V iON+ 2.0 Ah Lithium-Ion Battery  <i>Battery Charge Time Max:</i>            24VCHRG-AC: 1 hr 20 min   24VCHRG-QC: 55 min   24VCHRG-DPC: 55 min  <i>Battery Runtime Max: 4 hr 20 min</i></p>	24VBAT-LTE
<p>4</p> 	<p>24V iON+ 2.5 Ah Lithium-Ion Battery  <i>Battery Charge Time Max:</i>            24VCHRG-AC: 1 hr 40 min   24VCHRG-QC: 1 hr 10 min   24VCHRG-DPC: 1 hr 10 min  <i>Battery Runtime Max: 5 hr 30 min</i></p>	24VBAT-LT
<p>5</p> 	<p>24V iON+ 4.0 Ah Lithium-Ion Battery  <i>Battery Charge Time Max:</i>            24VCHRG-AC: 2 hrs 40 min   24VCHRG-QC: 1 hr 50 min   24VCHRG-DPC: 1 hr 50 min  <i>Battery Runtime Max: 8 hr 40 min</i></p>	24VBAT
<p>6</p> 	<p>24V iON+ 5.0 Ah Lithium-Ion Battery  <i>Battery Charge Time Max:</i>            24VCHRG-AC: 3 hrs 20 min   24VCHRG-QC: 2 hr 20 min   24VCHRG-DPC: 2 hr 30 min  <i>Battery Runtime Max: 10 hr 50 min</i></p>	24VBAT-XR
<p>7</p> 	<p>24V iON+ Lithium-Ion Battery Quick Charger</p>	24VCHRG-QC
<p>8</p> 	<p>24V iON+ Lithium-Ion Battery Dual Port Charger</p>	24VCHRG-DPC

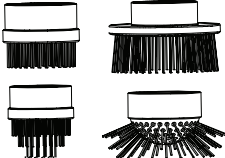
Accessories	Item	Model
	Large Flat Brush	24V-PWSCRB-LB
	Small Flat Brush	24V-PWSCRB-SB
	Cone Brush	24V-PWSCRB-CB
	Round Brush	24V-PWSCRB-RB
	4-PK Replacement Brushes	24V-PWSCRB-4PK

**NOTE:** Accessories are subject to change without any obligation on the part of Snow Joe® + Sun Joe® to provide notice of such changes. Accessories can be ordered online at [sunjoe.com](http://sunjoe.com) or via phone by contacting the Snow Joe® + Sun Joe® customer service center at 1-866-SNOWJOE (1-866-766-9563).





## SNOW JOE® + SUN JOE® REFURBISHED GOODS WARRANTY

### GENERAL CONDITIONS:

Snow Joe® + Sun Joe® operating under Snow Joe®, LLC warrants this refurbished product to the original purchaser for 90 days against defects in material or workmanship when used for normal residential purposes. If a replacement part or product is needed, it will be sent free of charge to the original purchaser except as noted below.

The duration of this warranty applies only if the product is put to personal use around the household. It is the owner's responsibility to correctly perform all maintenance and minor adjustments explained in the owner's manual.

### HOW TO OBTAIN YOUR REPLACEMENT PART OR PRODUCT:

To obtain a replacement part or product, please visit [snowjoe.com/help](http://snowjoe.com/help) or email us at [help@snowjoe.com](mailto:help@snowjoe.com) for instructions. Please be sure to register your unit beforehand to speed up this process. Certain products may require a serial number, typically found on the decal affixed to the housing or guard of your product. All products require a valid proof of purchase.

### EXCLUSIONS:

- Wearing parts like belts, augers, chains and tines are not covered under this warranty. Wearing parts can be purchased at [snowjoe.com](http://snowjoe.com) or by calling 1-866-SNOWJOE (1-866-766-9563).
- Batteries are covered in full for 90-days from the date of purchase.

Snow Joe® + Sun Joe® may from time to time change the design of its products. Nothing contained in this warranty shall be construed as obligating Snow Joe® + Sun Joe® to incorporate such design changes into previously manufactured products, nor shall such changes be construed as an admission that previous designs were defective.

This warranty is intended to cover product defects only. Snow Joe®, LLC is not liable for indirect, incidental or consequential damages in connection with the use or misuse of the Snow Joe® + Sun Joe® products covered by this warranty. This warranty does not cover any cost or expense incurred by the purchaser in providing substitute equipment or service during reasonable periods of malfunction or non-use of this product while waiting for a replacement part or unit under this warranty. Some states do not allow exclusions of incidental or consequential damages so the above exclusions may not apply in all states. This warranty may give you specific legal rights in your state.

### HOW TO REACH US:

We're here to help Monday through Friday from 9AM to 7PM EST and Saturday and Sunday 9AM to 4PM. You can reach us at 1-866-SNOWJOE (1 866-766-9563), online at [snowjoe.com](http://snowjoe.com), via email at [help@snowjoe.com](mailto:help@snowjoe.com) or tweet us @snowjoe.

### EXPORTS:

Customers who have purchased Snow Joe® + Sun Joe® products exported from the United States and Canada should contact their Snow Joe® + Sun Joe® distributor (dealer) to obtain information applicable to your country, province or state. If for any reason, you are not satisfied with the distributor's service, or if you have difficulty obtaining warranty information, contact your Snow Joe® + Sun Joe® seller. If in the event your efforts are unsatisfactory, please reach out to us directly.



[sunjoe.com](http://sunjoe.com)